



In vitro delivery of doxycycline hydrochloride based on a porous membrane-based aqueous–organic partitioning system

Qiuxi Fan^a, Kamalesh K. Sirkar^{a,*}, Yiping Wang^b, Bozena Michniak^c

^a *Otto H. York Department of Chemical Engineering, New Jersey Institute of Technology, 371 Tiernan Hall, University Heights, Newark, NJ 07102, USA*

^b *Ernest Mario School of Pharmacy, Rutgers, The State University of New Jersey, Piscataway, NJ 08854, USA*

^c *Department of Pharmacology and Physiology, UMDNJ-New Jersey Medical School, Newark, NJ 07103, USA*

Received 31 December 2003; accepted 14 May 2004

Available online 17 July 2004

Abstract

This work investigated the controlled release of an antibiotic drug, doxycycline HCl, from its solution/suspension in an organic solvent in a reservoir through a porous membrane employing aqueous–organic partitioning with or without a mouse skin to simulate a skin patch. The reservoir contained the agent in solution in the solvent 1-octanol or its dispersion/solution in the solvent mineral oil with or without an enhancer. The porous membranes employed with water-in-pores were hydrophobic Celgard® 2400 of polypropylene and hydrophilized polyvinylidene fluoride (PVDF). Conventional Franz diffusion cells as well as a skin patch were used. The transport rates of the agent observed through both Celgard® and PVDF membranes could be successfully described by Fickian diffusion through the water-filled pores when the appropriate organic–aqueous partition coefficient was incorporated. The light mineral oil-based system yielded much higher permeability due to the much lower organic–aqueous partition coefficient of the antibiotic in light mineral oil. The optimized skin patch systems yielded drug flux and permeability values similar to their relevant membrane systems. The addition of a mouse skin beneath the patch drastically reduced the drug transfer rate. Among a number of enhancers used to correct this deficiency, linoleic acid at 10% level in the reservoir solution was found to yield a flux of $2.7 \pm 0.5 \mu\text{g}/\text{cm}^2 \text{ h}$ and a permeability of $2.7e-04 \pm 5.0e-05 \text{ cm}/\text{h}$. These values are higher than the values available in literature obtained with full thickness human cadaver skin.

© 2004 Elsevier B.V. All rights reserved.

Keywords: Controlled release; Microporous and skin membranes; Aqueous-organic partitioning; Suspension; Doxycycline hydrochloride; Patch

1. Introduction

A variety of reservoir-based and other types of polymeric controlled release devices are in use [1,2]. A particular type of membrane-based patch employs a

reservoir of a liquid, gel or sol agent carrier surrounded by a nonporous or porous membrane wall [3]. For the porous membrane wall, the release rate of the agent is controlled primarily by diffusion vis-à-vis the membrane pore characteristics regardless of the nature of the pore liquid as an extension of the reservoir liquid. Farrell and Sirkar [4] described an alternate system where the liquid phase in the pores of the porous membrane surrounding the reservoir was

* Corresponding author. Tel.: +1-973-596-8447; fax: +1-973-642-4854.

E-mail address: sirkar@adm.njit.edu (K.K. Sirkar).

immiscible with the reservoir liquid phase such that aqueous–organic partitioning of the agent controlled its release rate. Such systems were studied experimentally [4,5]. Models were developed for two cases: agent in solution in the reservoir [5], agent in solution in the reservoir in the presence of dispersed solid agents in the reservoir solution of the agent [6].

Compared to other conventional controlled release technologies, preparation of such an aqueous–organic partition-based system is convenient and does not require dispersion of the agent into a polymer and the attendant processing steps. Correspondingly, the issues of agent stability during loading in a polymer, solvent handling in wet phase inversion, need to shape the polymer, etc. are absent here. By appropriate selection of the organic solvent/agent/membrane system, considerable flexibility in the release rate of the agent can be realized in aqueous–organic partition-based system [4].

Studies of controlled release of small molecules, e.g., nicotine (M.W.: 162), caffeine (M.W.: 194), benzoic acid (M.W.: 122) were carried out in the above systems [4–6]. The transport of these smaller molecules through a mouse skin is quite high [7]. Molecules of considerable interest are often larger, more complex and frequently polar, and therefore difficult to transport through the skin. It is certainly true of the broad-spectrum antibiotic, doxycycline hydrochloride (HCl) of molecular weight 480.1, which is licensed for the prophylaxis and treatment of malaria [8]. It would be of considerable interest to explore whether the reservoir-based technique based on the relatively simple aqueous–organic partitioning [4–6] through a porous membrane could be employed in a skin patch to deliver important antibiotics, e.g., doxycycline HCl. Although iontophoretic delivery of drugs of molecular weight larger than doxycycline HCl through the skin is being achieved recently [9], a molecular weight of 500 was considered for quite

some time to be an upper limit for transdermal drug delivery [10]. In this context, transdermal drug delivery of doxycycline HCl using aqueous–organic partitioning is considered demanding. Such a goal has been explored in this study in a stepwise fashion.

The release of the agent using aqueous–organic partitioning from its solution in 1-octanol has been studied first; its release from a dispersion/solution in mineral oil was explored next. Several microporous membranes were employed to achieve aqueous–organic partitioning between the organic reservoir phase and the aqueous pore phase. The patch application was then simulated by employing a mouse skin next to the microporous membrane in the presence or absence of several enhancers introduced in the reservoir liquid phase, i.e., mineral oil. The excellent observed release rates of this agent achieved will be illustrated. The observed rates of release in configurations not using the mouse skin have also been compared with predictions from a simplified model of the aqueous–organic partition-based system.

2. Materials and methods

2.1. Materials

2.1.1. Membranes

Celgard® 2400 hydrophobic polypropylene flat films were from Celgard (Charlotte, NC). Polyvinylidene fluoride (PVDF) Durapore hydrophilized films were purchased from Millipore (Bedford, MA). The polymer PVDF is naturally hydrophobic; an additional polymerized layer on the membrane surface and pores makes it hydrophilic. Table 1 provides details of the membrane properties and dimensions.

Skin membranes: Male hairless mice, strain SkH1, 8 weeks old, were supplied by Charles River Laboratories (Wilmington, MA). Mice were euthanized by

Table 1
Characteristic properties of different polymeric membranes

Microporous membrane	Material	Pore size (µm)	Porosity ^a	Tortuosity	Membrane thickness (µm)
Celgard® 2400 film	Polypropylene	0.035 × 0.2	0.38	5.0 ^b	25
PVDF film	Polyvinylidene fluoride	0.1	0.7	2.58 ^c	100

^a Supplied by manufacturer.

^b Prasad and Sirkar [11].

^c Chen et al. [12].

carbon dioxide asphyxiation. Their skins were excised and kept at $-30\text{ }^{\circ}\text{C}$ until used.

2.1.2. Chemicals

The agent, doxycycline HCl (M.W.: 480.1), Sigma brand, was donated by Integrated Pharmaceuticals, Boston, MA. Potassium phosphate monobasic anhydrous and azone, cineole, linoleic acid were obtained from Sigma, St. Louis, MO. Light mineral oil, 1-octanol, ethanol, methanol (HPLC-grade) and acetonitrile (HPLC-grade) were purchased from Fisher Scientific, Fair Lawn, NJ. Phosphate buffered saline (PBS) was supplied by Fluka, Milwaukee, WI. Bio-PSA[®] 7-4302 silicone adhesive was from Dow Corning, Midland, MI.

2.1.3. Patch

Patches used were supplied by Hill Top Research, Cincinnati, OH. Fig. 1 is a schematic of the patch.

2.2. Experimental setup

Two different diffusion cells were used. The first one consists of two reservoir-based-controlled release cells, each having a volume of about 0.9 ml and a diffusional area of 2.53 cm^2 (shown in Fig. 2) [13]. The other one is the standard Franz diffusion cell (Permegear, Riegelsville, PA), with a diffusional area of 0.64 cm^2 and a receptor compartment volume of 5.1 ml; for the patch system, the relevant parameters are: 3.14 cm^2 and 9.5 ml.

2.3. Experimental procedure

2.3.1. Solution

With 1-octanol as solvent, either 250 mg (Sol. 1) or 500 mg (Sol. 2) of the agent was transferred into 50 ml 1-octanol. Then the solution was stirred for 12 h till it became clear for use.

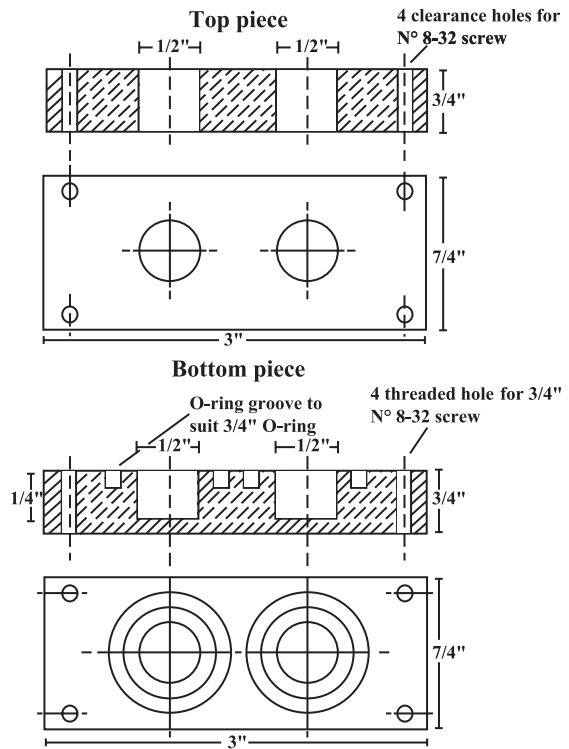

Fig. 2. The two reservoir-based controlled release cell used for film studies [13].

For light mineral oil as solvent, the agent has a much lower solubility than that in 1-octanol. The amount added was 500 mg into 50 ml of light mineral oil so that there was enough agent present in a suspension. In another case, the agent sample (500 mg) was suspended into 50 ml of 10% v/v ethanol in light mineral oil and agitated over a magnetic stirrer for 12 h. Fifteen minutes before applying the agent solution into the donor part of the diffusion cells, certain amount (5, 10, 20% v/v) of enhancer (azone, cineole, or linoleic acid) was sometimes added into the solution with a suspension

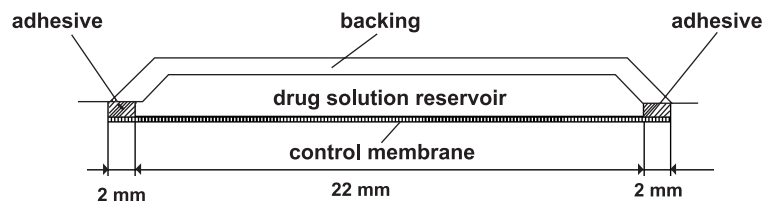

Fig 1. Schematic of Hill Top[®] patch.

and thoroughly mixed. For the 1-octanol-based systems, no ethanol or enhancer was applied.

2.3.2. Membrane preparation

A piece of Celgard® or PVDF film was cut into a circular shape having an area same as that of the diffusion cells. The Celgard® film was wetted by the following steps: the film was dipped in 40% v/v ethanol/DI water solution for 4 h, then was transferred to 20% v/v ethanol/DI water solution overnight; after that the film was moved to 5% v/v ethanol/DI water solution overnight; the last step was to soak it in DI water overnight. Then these circular films were soaked into 10% v/v ethanol/deionized water for 10 min; the water drops remaining on both surfaces were removed by rolling a glass rod. For the two-reservoir-based cells, the wetted membranes were placed over each reservoir, and the cells were closed.

In the case of skin membranes, the mouse skins were first taken out from the freezer ($-30\text{ }^{\circ}\text{C}$) and put into a beaker filled with room temperature water until they were defrosted. The mice skins from their dorsal (back) sites were removed from the adhering fat deposits and then were cut into small pieces of appropriate size and carefully mounted on top of the diffusion cells and left to hydrate. After 1 hour of hydration, a drop of light mineral oil was applied on the surface of each piece of mouse skin to wet it for 10 min. Then each piece of skin was covered carefully with the circular membrane piece.

2.3.3. In vitro drug-release studies

The donor part of the Franz diffusion cell was filled with 0.5 ml of the suspension containing agent solution, and the receptor compartment with isotonic phosphate buffer (pH 7.2) containing 0.1% v/v of 36% aqueous formaldehyde as preservative [14]. Receptor solution temperature was maintained at $37 \pm 0.5\text{ }^{\circ}\text{C}$ and was constantly stirred at 600 rpm. The top of the donor compartment was covered with triple layers of Parafilm®. At predetermined times, 300 μl samples were taken from the receptor compartment over a total period of either 24 or 120 h and were immediately replaced by the same volume of a fresh buffer solution. The samples were kept frozen at $4\text{ }^{\circ}\text{C}$ prior to analysis by high performance liquid chromatography (HPLC). The results are based on averages from three Franz cells.

The amount of the agent withdrawn was corrected in the subsequent calculations of cumulative amount penetrated. For the two-reservoir-cell, after preparation of the flat membrane system, the device was submerged in a volume of water chosen for analytical convenience, between 150 and 750 cm^3 . Samples (200 μl) were withdrawn periodically from the aqueous phase in the glass vessel until agent concentration remained constant for three consecutive measurements. The sample volume was negligible compared with the total aqueous volume and the agent concentration in the surrounding water was extremely low relative to its saturation concentration; therefore medium changes were not necessary. The mass of agent released was calculated from the aqueous concentration and bath volume, and plotted as a function of time to establish release profiles.

2.3.4. Distribution coefficient study

A certain amount of agent was transferred to different volumes of deionized water respectively. Then the same volume of organic solvent, e.g., 1-octanol or light mineral oil was added into the same container. Each container was put on the stir plate and stirred for 24 h. The aqueous phase was centrifuged and its concentration of agent was analyzed by HPLC as follows.

2.3.5. HPLC analysis

Samples were analyzed by reverse phase high performance liquid chromatography, using a $4.6 \times 150\text{-mm}$ Phenomenex Luna C18 5- μm ODS column fitted to a Hewlett Packard 1090 automated isocratic system, with UV detection at 346 nm [8]. The mobile phases were 45:55 of acetonitrile and 0.02 M KH_2PO_4 in deionized water. The pH of this salt eluent was adjusted to 3.0. Before use, the solution was degassed and filtered through 0.2- μm nylon filter. The injection volume was 40 μl and the flow rate was set at 1.0 ml min^{-1} . Under these conditions, a retention time of approximately 2 min was obtained for the agent.

2.4. Data processing

The permeation parameters of the agent were calculated by plotting the cumulative corrected amounts ($\mu\text{g/cm}^2$) of the drug permeated through the membrane versus time (h). Calculation of the membrane penetration parameters was based on the assumption that the

amount of enhancer applied on the membrane is small, so there will be a minimal effect on agent's solubility. The slope of the linear portion of the graph provided average flux value (J) at steady state ($\mu\text{g}/\text{cm}^2 \text{ h}$).

Permeability (P) was calculated by:

$$\frac{\Delta C_{\text{receptor}}}{\Delta t \cdot A_{\text{receptor}}} \cdot \frac{V_{\text{receptor}}}{C_{\text{donor}}} \quad (\text{cm/h}) \quad (1)$$

$\Delta C_{\text{receptor}}$ ($\mu\text{g}/\text{ml}$): the difference of agent concentration in the receptor part in the given time Δt (h); C_{donor} ($\mu\text{g}/\text{ml}$): agent concentration in the donor part.

Statistical analysis was performed using one-way analysis of variance (one-way ANOVA).

3. Results and discussion

3.1. Distribution coefficient K

The effective distribution coefficient K for doxycycline HCl between 1-octanol and water was found to be 30, while that between light mineral oil and water was 0.13. Here K is defined as

$$K = \frac{\text{Concentration of agent in organic phase}}{\text{Total concentration of agent in aqueous phase}} \quad (2)$$

Note that in the aqueous phase, doxycycline HCl exists as the original base (Doxy) as well as doxycycline H^+ (Doxy H^+). The sum of these two concen-

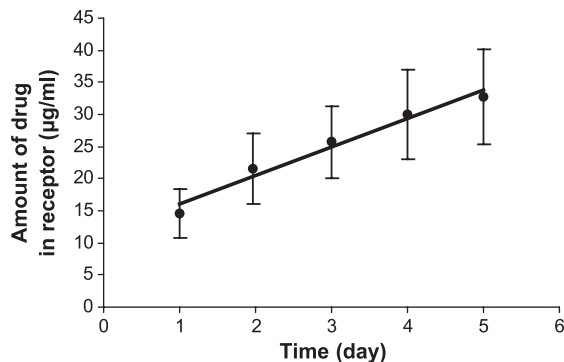

Fig. 3. Controlled release of doxycycline HCl through Celgard® 2400 membrane in the two reservoir-based controlled release cell for the first 5 days (reservoir solvent, 1-octanol. Sol. 2).

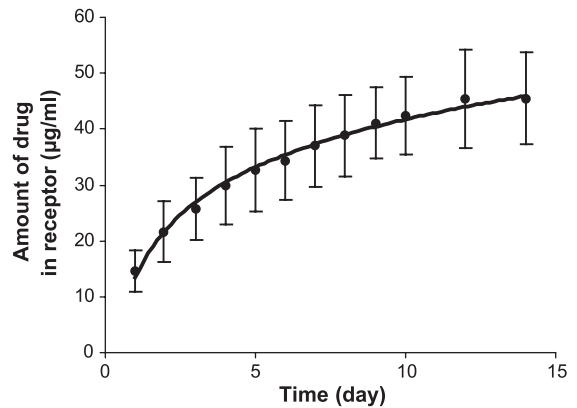

Fig. 4. Controlled release of doxycycline HCl through Celgard® 2400 membrane in the two reservoir-based controlled release cell for 14 days (reservoir solvent, 1-octanol. Sol. 2).

trations is the total concentration of the agent which was used in the definition of K given in Eq. (2) above.

3.2. Release profiles from polymeric membranes using 1-octanol and light mineral oil as vehicles

Two different kinds of polymeric membranes were studied: hydrophobic Celgard® 2400 and hydrophilic PVDF. All experiments used either 1-octanol or light mineral oil as the solvent for the agent in either two reservoir-based cell or Franz diffusion cell.

3.2.1. Release from Celgard® 2400 membrane in two reservoir-based cell

For the release from a 1-octanol-based reservoir system with Celgard® 2400 membrane, in the beginning, the change of concentration in the receiving reservoir was proportional to the time (Fig. 3). Thus, it was a zero order release for this period [4,15]; a straight line behavior was observed. Then a first order release was observed with the characteristics of a quadratic curve (Fig. 4) [4,15]. It should be noted that zero order release can be continued for longer lengths of time if the agent concentration in the receiver solution were much smaller (as would be true in in vivo studies).

3.2.2. Release from PVDF membrane

The hydrophilic PVDF membrane was tried next to compare its release characteristics with those of Celgard® 2400. For this membrane, Franz diffusion

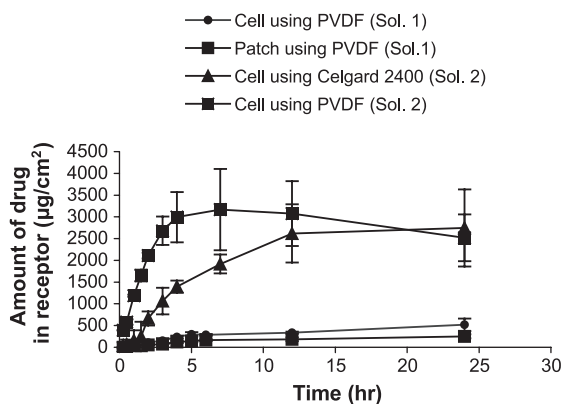

Fig. 5. In vitro release of doxycycline HCl using 1-octanol as vehicle through PVDF or Celgard® 2400 membrane over 24 h.

cells were used. The results of release are presented in Fig. 5. Table 2 illustrates the permeation data from different systems.

Obviously, the PVDF membrane has a somewhat higher permeability and flux than Celgard® 2400. Theoretically, from the formula of flux of the permeating species [16]

$$J = D_{\text{eff}} \frac{\Delta C}{l} = \frac{D_{\text{eff}}}{l} (C_{1D} - C_{1R})$$

$$= \frac{D_{\text{eff}}}{l} \left(\frac{C_{1D}^{\text{Oct}}}{K} - C_{1R} \right) \quad (3)$$

in which K is partition coefficient, D_{eff} is the effective diffusion coefficient in the membrane, ΔC is the concentration difference in the pore liquid of the two external solution–pore liquid interfaces on two sides: C_{1D} is the concentration in the pore liquid of the donor side and C_{1R} is that of the receptor side; l is the membrane thickness. The last formula is utilized in the following calculation with $C_{1R} \cong 0$, effectively zero concentration in the reservoir vessel having an aqueous phase; the donor chamber has the organic phase.

Table 2
Permeation data using 1-octanol as vehicle for different diffusion systems

Diffusion systems	Permeability (cm/h)	Flux ($\mu\text{g}/\text{cm}^2 \text{ h}$)	Q_{24}^a ($\mu\text{g}/\text{cm}^2$)
2 reservoir-based cell system using Celgard® 2400 membrane (Sol. 2)	0.002 ± 0.0003	18.3 ± 3.1	1152 ± 300
Franz diffusion cell using Celgard® 2400 membrane (Sol. 2)	0.014 ± 0.0006	138.9 ± 6.1	2745 ± 888
Franz diffusion cell using PVDF membrane (Sol. 1)	0.015 ± 0.003	72.8 ± 12.2	516 ± 146
Franz diffusion cell using PVDF membrane (Sol. 2)	0.015 ± 0.002	149.7 ± 21.8	2521 ± 538
Hill Top® patch using PVDF membrane (Sol. 1)	$0.007 \pm 7.14\text{e} - 05$	36.0 ± 0.4	395 ± 3

^a Q_{24} , receptor concentration after 24 h.

The partition coefficient K of the agent between the reservoir organic solvent 1-octanol and water is the same in the case of both membranes, Celgard® 2400 and PVDF. The effective diffusion coefficient of the drug through water in the porous membrane may be defined as [11]

$$D_{\text{eff}} = \frac{D_{\text{water}} \varepsilon_m}{\tau_m} \quad (4)$$

in which ε_m and τ_m are the porosity and tortuosity of the membrane, respectively, and D_{water} is the diffusion coefficient in free solution. For Celgard®, $\varepsilon_m = 0.38$ and $\tau_m = 5$ whereas for PVDF, $\varepsilon_m = 0.7$ and $\tau_m = 2.58$. Therefore, (D_{eff}/l) factor in Eq. (3) is essentially the same for both Celgard® 2400 and PVDF films $((\varepsilon_m/\tau_m)l)$: $(0.38/5 \times 25)$ ($= 0.0030 \mu\text{m}^{-1}$) for the Celgard® 2400 film and $(0.7/2.58 \times 100)$ ($= 0.0027 \mu\text{m}^{-1}$) for the PVDF film).

There are two species of doxycycline drug in the aqueous phase, the original base doxycycline (Doxy) and doxycycline H^+ (Doxy H^+). There are two unknowns here whose values are needed before the total agent flux can be calculated. First, the relative distribution between the two species has to be determined. Second, their diffusion coefficients also need to be known. The first dissociation equilibrium constant K_1 for doxycycline H^+ is $10^{-3.3}$ [17]:

$$K_1 = 10^{-3.3} = \frac{[\text{Doxy}] \cdot [\text{H}^+]}{[\text{DoxyH}^+]} \quad (5)$$

Since the pores contained only an aqueous solution of DoxyHCl, $[\text{DoxyH}^+] + [\text{H}^+] \cong [\text{Cl}^-]$. For a total agent concentration of Sol. 2, $C_T = C_{\text{Doxy}} + C_{\text{DoxyH}^+} = \frac{C_{1D}^{\text{Oct}}}{K} = \frac{10^4}{30} \mu\text{g}/\text{ml} = 6.94 \cdot 10^{-4} \text{ mol}/\text{l}$, the following values were obtained by the solution of a quadratic equation obtained from Eq. (5): $C_{\text{Doxy}} = 157 \mu\text{g}/\text{ml}$ and $C_{\text{DoxyH}^+} = 176 \mu\text{g}/\text{ml}$. It was assumed that their

concentration in the receptor was zero. So the total agent flux was:

$$J = \frac{D_{\text{Doxy}} \cdot \varepsilon_m}{l \cdot \tau_m} (C_{\text{Doxy}} - 0) + \frac{D_{\text{DoxyH}^+} \cdot \varepsilon_m}{l \cdot \tau_m} (C_{\text{DoxyH}^+} - 0) \quad (6)$$

The diffusion coefficients of doxycycline in free solution ($D_{\text{Doxy,water}}$) can be obtained from the Wilke and Chang Equation [18] and is equal to $3.93 \times 10^{-6} \text{ cm}^2/\text{s}$. The diffusion coefficient of D_{DoxyH^+} compound is to be obtained from considerations of diffusion potential-based diffusion coefficient $D_{\text{DoxyH}^+\text{Cl}^-}$ obtained from the individual values of D_{DoxyH^+} and D_{Cl^-} and their charges [19]:

$$D_{\text{DoxyH}^+\text{Cl}^-} = \frac{D_{\text{DoxyH}^+} \cdot D_{\text{Cl}^-} (z_+ - z_-)}{(z_+ \cdot D_{\text{DoxyH}^+} - z_- \cdot D_{\text{Cl}^-})} \quad (7)$$

D_{DoxyH^+} for this calculation is assumed essentially equal to $3.93 \times 10^{-6} \text{ cm}^2/\text{s}$ corresponding to the original base D_{Doxy} . Here $z_+ = +1$, $z_- = -1$ and $D_{\text{Cl}^-} = 2.03 \times 10^{-5} \text{ cm}^2/\text{s}$ [19], so that

$$D_{\text{DoxyH}^+\text{Cl}^-} = \frac{3.93 \times 10^{-6} \cdot 2.03 \times 10^{-5} [1 - (-1)]}{3.93 \times 10^{-6} - (-2.03 \times 10^{-5})} = 6.59 \times 10^{-6} \text{ cm}^2/\text{s}$$

Therefore, for the Celgard® 2400 film, the total flux of doxycycline HCl in both forms from Eq. (6) is:

$$J = (3.93 \times 10^{-6})(0.003 \times 10^4)(157 - 0)3600 + (6.59 \times 10^{-6})(0.003 \times 10^4)(176 - 0)3600 = 191.9 \mu\text{g}/\text{cm}^2 \text{ h}$$

Since the concentrations in the receptor part were always much less than the donor part and the receptor side was well mixed, C_{IR} was assumed to be 0 for all

species for flux calculation by Eq. (6). (The value without consideration of ionization is $136.0 \mu\text{g}/\text{cm}^2 \text{ h}$). Results of theoretical flux values (J) obtained when values of all the experimental parameters were introduced into Eq. (6), are shown in Table 3. This table also includes the corresponding experimentally observed values.

Obviously, the flux results from the experimental data are quite close to those calculated from the model equation. For the flux from the two reservoir-based cell, however, with no stirring in the receptor part, the existing stagnant layer in such a system has to be considered. As shown in Fig. 2, two small donor cells immersed in a 200-ml reservoir may be considered in analogy to the diffusion from a droplet to a stagnant fluid around it. From the volume of each cell (0.9 cm^3), the characteristic dimension of an equivalent sphere is 1.2 cm. The Sherwood number (Sh) for this case is 2 [20]. Therefore, the mass transfer coefficients, k_{Doxy} and k_{DoxyH^+} , are:

$$k_{\text{Doxy}} = \frac{D_{\text{Doxy}} \cdot Sh}{d} = \frac{3.93 \times 10^{-6} \cdot 2}{1.2} = 6.55 \times 10^{-6} \text{ cm/s}$$

$$k_{\text{DoxyH}^+} = \frac{D_{\text{DoxyH}^+} \cdot Sh}{d} = \frac{6.59 \times 10^{-6} \cdot 2}{1.2} = 10.78 \times 10^{-6} \text{ cm/s} \quad (8)$$

Introducing it into the flux equation, one obtains

$$J = (k_{\text{Doxy}} \cdot \Delta C_{\text{Doxy}} + k_{\text{DoxyH}^+} \cdot \Delta C_{\text{DoxyH}^+}) \times 3600 \text{ s/h} \cdot 2 = 21.3 \mu\text{g}/\text{cm}^2 \text{ h} \quad (9)$$

which is close to the experimental value. It is to be noted that the permeabilities calculated by Eq. (1) utilized the total solute concentration in the organic solvent in the reservoir. If the corresponding aqueous phase solubility is used as the value of C_{donor} , it will

Table 3
Comparison of theoretical flux values and experimental ones

Membrane	Solution	Theoretical value ($\mu\text{g}/\text{cm}^2 \text{ h}$)	Experimental value ($\mu\text{g}/\text{cm}^2 \text{ h}$)
Celgard® 2400 membrane	Sol. 2 (two reservoir-based cell)	21.3	18.3 ± 3.1
	Sol. 2 (Franz cell)	191.9	138.9 ± 6.1
PVDF membrane	Sol. 1 (Franz cell)	86.4	72.8 ± 12.2
	Sol. 2 (Franz cell)	172.7	149.7 ± 21.8

be much lower for 1-octanol; therefore, the value of permeability P will go up. For light mineral oil considered later, it will go down since K for light mineral oil is 0.13. Note furthermore, that for the dispersion in light mineral oil, C_{Donor} included both soluble and insoluble doxycycline HCl.

The results of transport for the patch system identified at the end of Table 2 will be considered now. It is clear that all of the permeation parameters of the patch system are lower than those from the Franz diffusion cell for the same PVDF membrane. It may be justified by the fact that the patch system was more complex with a number of uncertainties compared to the Franz cell with the membrane mounted. In the case of the patch, the membrane was sealed to the agent reservoir by an adhesive; the extent of agent absorption in the adhesive was unknown. Given other uncertainties such as bubbles created during patch preparation (difficult to remove during experiments) and unexpected leaks from the periphery of reservoir, it is not surprising that the release rate from the first sample of patch was not as good as those from the Franz diffusion cell system.

To improve the permeability, the patch system was optimized: instead of filling the agent suspension directly in the reservoir, it was transferred into a double layer of cotton pad (originally housed in the reservoir of the patch obtained from the manufacturer), then covered with a PVDF membrane. With the cotton pad holding the agent solution, the chances of peripheral leakage were considerably reduced, the creation of bubbles was avoided, and the patch became a stable release source. For this revised configuration, permeation results were close to those of its relevant membrane system as shown in Table 4 and Fig. 6.

Since hydrophobic Celgard® 2400 films needed several days of pretreatment to get wetted for use, hydrophilic PVDF membrane was used in the following experiments. The solvent 1-octanol has a strong odor; therefore, light mineral oil was employed to test

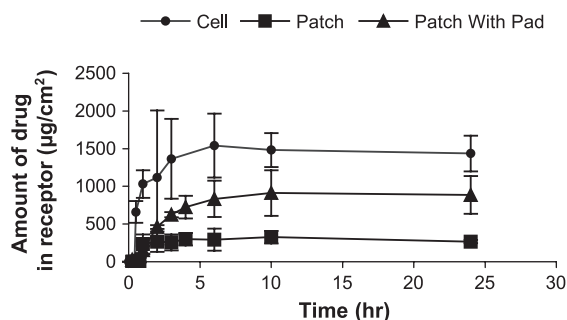

Fig. 6. In vitro release of doxycycline HCl using light mineral oil as vehicle through PVDF membrane over 24 h.

whether it would be a good replacement with light color and odorless property. Fig. 6 shows the controlled release profiles from the Franz cell system and the patch-based system; Table 4 gives the permeation data results from these setups.

On comparing these results with those based on 1-octanol (Table 2), it is observed that the permeation parameter is halved using 1-octanol; further the fluxes are close to each other although much less solute was dissolved in the light mineral oil (around 550 µg/ml) compared to that in 1-octanol. Applying light mineral oil as the vehicle actually decreases the solubility of the agent strongly compared to 1-octanol; it forms a suspension, which decreases the agent concentration in the solvent for partitioning into water in the membrane pores. However, the distribution coefficients for the agent between 1-octanol/water and mineral oil/water are 30 and 0.13. It is the principal reason why in light mineral oil system, this antibiotic has a much higher permeability. So the solvent choice was narrowed down to light mineral oil for the experiments to be described next.

With these results, it is clear that a porous polymeric membrane in an aqueous–organic partitioning system should not be a major obstacle for the agent to pass through. So in the next part, a mouse skin was used for test with the polymeric membrane on top of it.

Table 4
Permeation data using light mineral oil as vehicle from different diffusion systems

Diffusion systems	Permeability (cm/h)	Flux (µg/cm² h)	Q_{24} (µg/cm²)
Franz diffusion cell using PVDF membrane	0.03 ± 0.006	145.7 ± 27.0	1435 ± 238
Hill Top® patch using PVDF membrane	0.004 ± 0.0008	21.6 ± 4.1	267 ± 22
Hill Top® patch using PVDF membrane and cotton pad	0.025 ± 0.003	133.0 ± 15.5	885 ± 250

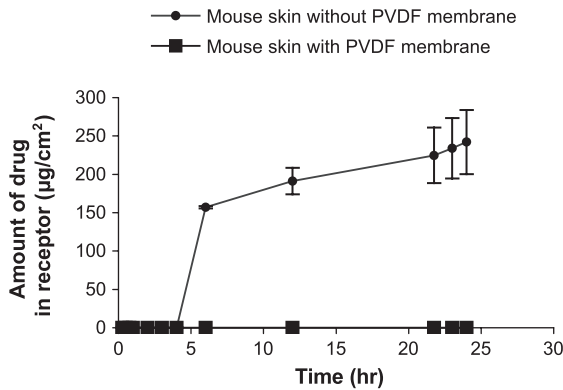

Fig. 7. In vitro release of doxycycline HCl through mouse skin with and without PVDF membrane over 24 h.

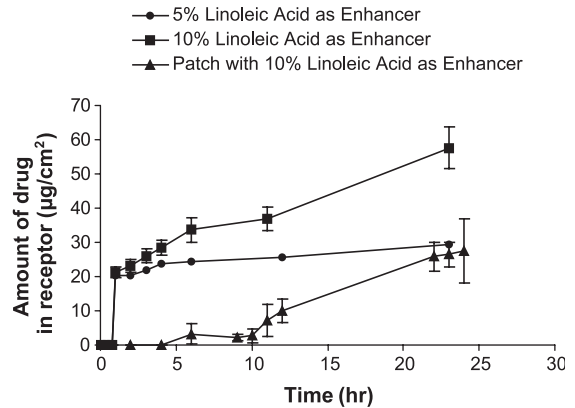

Fig. 8. In vitro release profile of doxycycline HCl with linoleic acid as enhancer through PVDF membrane and mouse skin over 24 h.

3.3. Release profiles from porous polymeric membrane and mouse skin using 10% ethanol in light mineral oil as vehicle in the reservoir

First, two control experiments were made: controlled release through the mouse skin without any polymeric membrane and through both polymeric membrane and mouse skin. Since the agent is a polar drug having a relatively higher molecular weight, 10% ethanol was used to enhance its transporting ability through skin. These release profiles are shown in Fig. 7, and the permeation parameters are given in Table 5.

It is clear that a significant drug permeation rate was achieved through the skin; but apparently there was essentially no agent going through the skin after passing through the aqueous pores of the PVDF membrane. The reason is likely to be as follows. In the case of the bare skin, the light mineral oil-based solution was directly in contact with the skin. The light mineral oil-based swelling of the skin facilitated the drug transport. However, when the water-filled pores of the PVDF membrane were imposed in between, there was no such facilitation since the skin

was no longer exposed to light mineral oil. The stratum corneum of the skin is expected to be a difficult medium for such a polar agent to go through unless facilitated by some means.

Next three kinds of enhancers were investigated: azone (amide), cineole (terpene) [21–23], and linoleic acid (fatty acid) in different percentage concentrations: 5%, 10%, 20% v/v. For the groups including azone and cineole respectively, very little of the agent accumulated in the receptor, while the agent permeability and flux were close to zero. Only linoleic acid as an enhancer yielded reasonable results as shown in Fig. 8 and Table 6. A patch system filled with 10% linoleic acid as enhancer was tried and yielded similar results in the Franz diffusion cell system, which are also included in this figure and table. In order to make the patch perform as well as the diffusion cell, the PVDF membrane was mounted on the patch with epoxy two days before the diffusion experiment through the mouse skin. In Table 6, data from a research group using human cadaver skin [8] are also listed for the purpose of comparison.

Table 5
Permeation data^a through mouse skin with and without PVDF membrane

Diffusion systems	Permeability (cm/h)	Flux (µg/cm ² h)	Q_{24} (µg/cm ²)
Hairless mouse skin only without PVDF membrane	0.001 ± 0.0002	9.8 ± 2.1	242 ± 41
Hairless mouse skin with PVDF membrane	0	0	0

^a Mineral oil in donor reservoir has 10% ethanol.

Table 6

Permeation data through PVDF membrane and mouse skin with different amounts of linoleic acid and through a human cadaver skin^a

Diffusion systems	Permeability (cm/h)	Flux ($\mu\text{g}/\text{cm}^2 \text{ h}$)	Q_{24} ($\mu\text{g}/\text{cm}^2$)
5% linoleic acid in drug solution	$1.6\text{e} - 04 \pm 3.2\text{e} - 05$	1.6 ± 0.3	36.5 ± 1.5
10% linoleic acid in drug solution	$2.7\text{e} - 04 \pm 5.0\text{e} - 05$	2.7 ± 0.5	63.1 ± 8.8
10% linoleic acid in drug patch	$1.7\text{e} - 04 \pm 1.5\text{e} - 05$	1.7 ± 0.2	27.6 ± 9.4
Doxycycline HCl across full-thickness human cadaver skin from ethanol vehicle [8]	$4.8\text{e} - 06 \pm 5\text{e} - 07$	0.13 ± 0.01	20^a

^a The reference has not given this data directly, and the number here was calculated from their Fig. 2 about the amount permeated versus time.

From its long-chain double bond structure similar to double lipid layer of skin, linoleic acid is believed to disrupt the skin lipid packing and make them (lipids) more dynamic [24]. This could explain why linoleic acid has significant effect on the agent permeation in the current investigation.

Mouse skin was used in this experiment since this was an initial feasibility study. It is known to the authors, however, that data from mouse skin provide higher permeability values than would be observed in human cadaver skin. Mouse skin in general is much thinner than human cadaver skin and also possesses a different lipid composition within the stratum corneum. In view of the data from a previously published cadaver skin experiment [8], it is expected that application of the membrane-skin system with aqueous-organic partitioning to a human skin in vitro would result in a reasonable flux.

In addition to the 24-h release, 120-h long-term release experiments have also been carried out. The permeation data were similar to those from the 24-h results with steady releasing rate achieved. These results suggest that it is possible to transfer this system

to a transdermal patch later. Fig. 9 shows the extended-time release profile.

4. Concluding remarks

The controlled release of a polar antibiotic drug of larger molecular weight, i.e., doxycycline HCl using aqueous-organic solute partitioning and microporous polymeric/mouse skin membranes has been studied. The reservoir had either the agent solution in octanol or a dispersion/solution of the agent in light mineral oil. Hydrophobic porous PP Celgard[®] membrane and hydrophilized porous PVDF membranes containing water in the pores were investigated. The transport rates of the agent through such membranes in aqueous-organic partition systems were accurately predicted using appropriate organic-aqueous partition coefficients. After a variety of tests, the porous PVDF membrane and light mineral oil were selected for in vitro test. Satisfactory release profiles were achieved not only from the in vitro membrane test but also from in vitro patch test after its optimization. These demonstrate the practical potential of aqueous-organic partitioning systems and porous membranes to achieve useful controlled release rates. Long-term release experiments spanning 120 h were also carried out and the results were satisfactory. The enhancer linoleic acid was essential to successful release in experiments using the mouse skin.

Acknowledgements

The donation of Celgard[®] 2400 membranes by Celgard, Charlotte, NC is acknowledged. The donations of doxycycline HCl by Integrated Pharmaceuticals, Boston, MA, and Bio-PSA[®] 7-4302 silicone

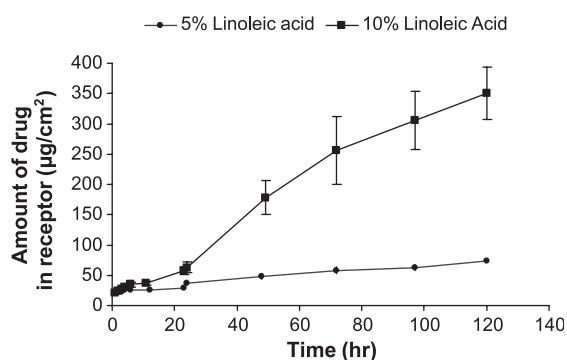

Fig. 9. In vitro release profile of doxycycline HCl with linoleic acid as enhancer through PVDF membrane and mouse skin over 120 h.

adhesive by Dow Corning, Midland, MI are also herewith acknowledged.

Note Added in Proof

The transport analysis is based on the following assumptions: (1) The agent DoxyHCl is completely dissociated in water into DoxyH⁺ and Cl⁻. (2) DoxyH⁺ is the protonated form of the original base Doxy. (3) Dimerization of both DoxyH⁺ and Doxy are neglected due to the low value of the total agent concentration $C_T \sim 6.9 \times 10^{-4}$ N [25].

References

- [1] A.L. Kydonieus (Ed.), *Controlled Release Technologies: Methods, Theory and Applications*, CRC Press, Boca Raton, FL, 1980.
- [2] R. Langer, *New methods of drug delivery*, *Science* 249 (1990) 1527.
- [3] A. Zaffaroni, *Novel drug delivery device*, U.S. Patent 3, 993, 073, 1976.
- [4] S. Farrell, K. Sirkar, A reservoir-type controlled release device using aqueous–organic partitioning and a porous membrane, *J. Membr. Sci.* 130 (1997) 265–274.
- [5] S. Farrell, K. Sirkar, A mathematical model of an aqueous–organic partition-based controlled release system using microporous membranes, *J. Control. Release* 61 (1999) 345–360.
- [6] S. Farrell, K. Sirkar, Mathematical model of a hybrid dispersed network-membrane-based controlled release system, *J. Control. Release* 70 (2001) 51–61.
- [7] Q. Fan, unpublished data, 2004.
- [8] N. Perkins, C. Heard, *In vitro* dermal and transdermal delivery of doxycycline from ethanol/migliol 840 vehicles, *Int. J. Pharm.* 190 (1999) 155–164.
- [9] A.V. Badkar, A.K. Banga, Electrically enhanced transdermal delivery of a macromolecule, *J. Pharm. Pharmacol.* 54 (2002) 907–912.
- [10] J.D. Bos, M.M.H.M. Meinardi, The 500 Dalton rule for the skin penetration of chemical compounds and drugs, *Exp. Dermatol.* 9 (2000) 165–169.
- [11] R. Prasad, K. Sirkar, Dispersion-free solvent extraction with microporous hollow-fiber modules, *AIChE J.* 44 (1988) 177–188.
- [12] H. Chen, A. Kovvali, S. Majumdar, K. Sirkar, Selective CO₂ separation from CO₂–N₂ mixtures by immobilized carbonate–glycerol membranes, *Ind. Eng. Chem. Res.* 38 (9) (1999) 3489–3498.
- [13] S. Farrell, *A Controlled Release Technique Using Microporous Membranes*, PhD Thesis, New Jersey Institute of Technology, 1996.
- [14] K.B. Sloan, H.D. Beall, W.R. Weimar, R. Villanueva, The effect of receptor phase composition on the permeability of hairless mouse skin in diffusion cell experiments, *Int. J. Pharm.* 73 (2) (1991) 97–104.
- [15] R. Guy, J. Hadgraft, in: J. Hadgraft, R.H. Guy (Eds.), *Transdermal Drug Delivery: Developmental Issues and Research Initiatives*, Marcel Dekker, New York, 1989, pp. 59–82, Chap. 3.
- [16] S.B. Kessler, E. Klein, in: W.S. Winston Ho, K.K. Sirkar, (Eds.), *Membrane Handbook*, Chapman & Hall, New York, 1992, Chap. 11, Kluwer Academic, Boston, 2001.
- [17] G.S. Libinson, Doxycycline, Potentiometric titration, *Antibiotiki* 22 (12) (1977) 1093–1095.
- [18] C.R. Wilke, P. Chang, Correlation of diffusion coefficients in dilute solutions, *AIChE J.* 1 (2) (1955) 264–270.
- [19] J.S. Newman, *Electrochemical Systems*, Prentice-Hall, Eaglewood Cliffs, NJ, 1973, p. 227, Table 75-1.
- [20] J.R. Welty, C.E. Wicks, E. Wilson, *Fundamentals of Momentum, Heat, and Mass Transfer*, 2nd edition, John Wiley & Sons, New York, 1976, pp. 634–649, Chap. 30.
- [21] D.A. Godwin, B.B. Michniak, Influence of drug lipophilicity on terpenes as transdermal penetration enhancers, *Drug Dev. Ind. Pharm.* 25 (1999) 905–915.
- [22] A.F. El-Kattan, C.S. Asbill, B.B. Michniak, The effect of terpene enhancer lipophilicity on the percutaneous permeation of hydrocortisone formulated in HPMC gel systems, *Int. J. Pharm.* 198 (2000) 179–189.
- [23] A.F. El-Kattan, C.S. Asbill, N. Kim, B.B. Michniak, The effects of terpene enhancers on the percutaneous permeation of drugs with different lipophilicities, *Int. J. Pharm.* 215 (2001) 229–240.
- [24] S. Chattaraj, R. Walker, in: E.W. Smith, H.I. Maibach (Eds.), *Percutaneous Penetration Enhancers*, CRC Press, Boca Raton, Florida, 1995, pp. 5–15, Chap. 1.2.
- [25] J.B. Bogardus, R.K. Blakwood Jr., Solubility of doxycycline in aqueous solution, *J. Pharm. Sci.* 68 (1979) 188–194.